

REVISIONS			
REV.	REV.	DESCRIPTION	DATE

1
2
3
4
5
6
7
8
9
10

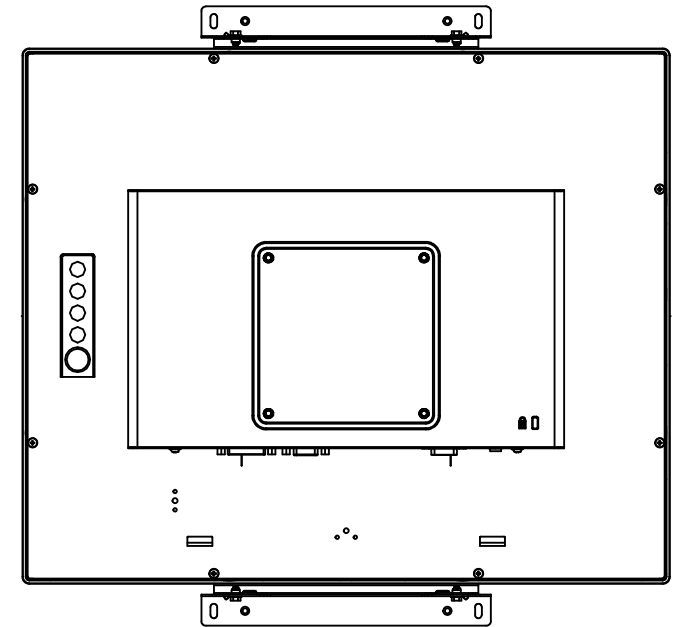
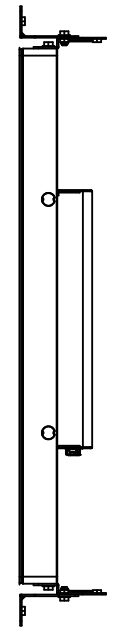
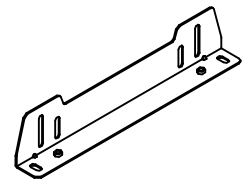
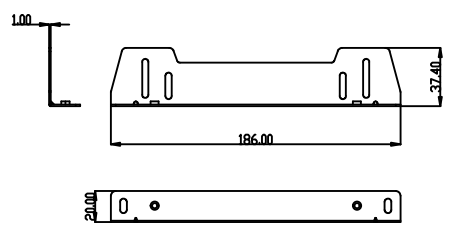
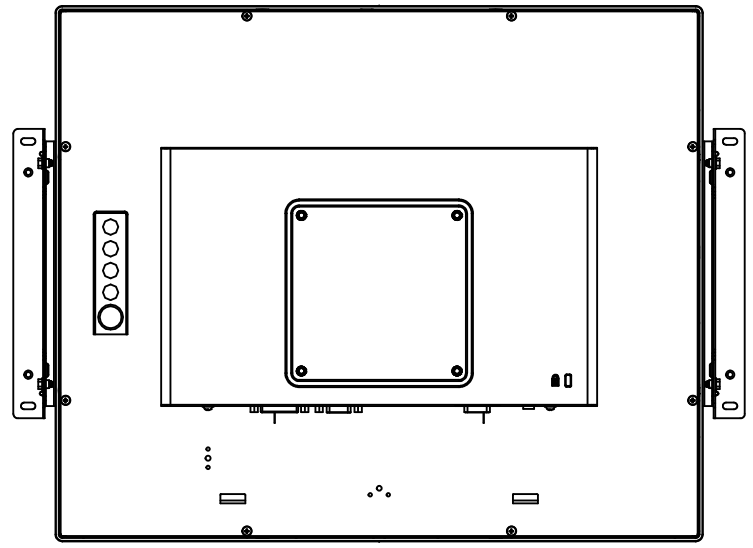
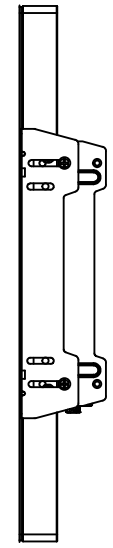
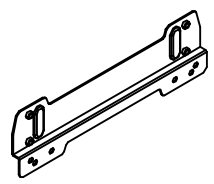
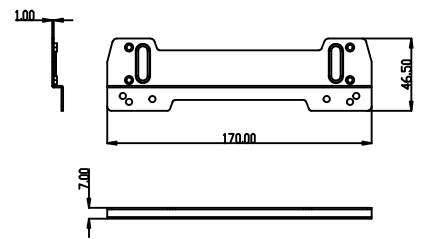

UNLESS OTHERWISE SPECIFIED TOLERANCES(mm)
EXCEED PRECISION (FOR PLASTIC)

DIMENSION	TOLERANCES(±)	
Hyper-	To	
0	25	0.1
25	250	0.2
250	400	0.3
400	500	0.6
500	630	0.9
630	800	1.2

REV.	REV.	DESCRIPTION	DATE	DATE	DATE	DATE

DESIGNED BY	DATE	DESIGNED BY	DATE	DESIGNED BY	DATE

THIRD ANGLE PROJECTION					